

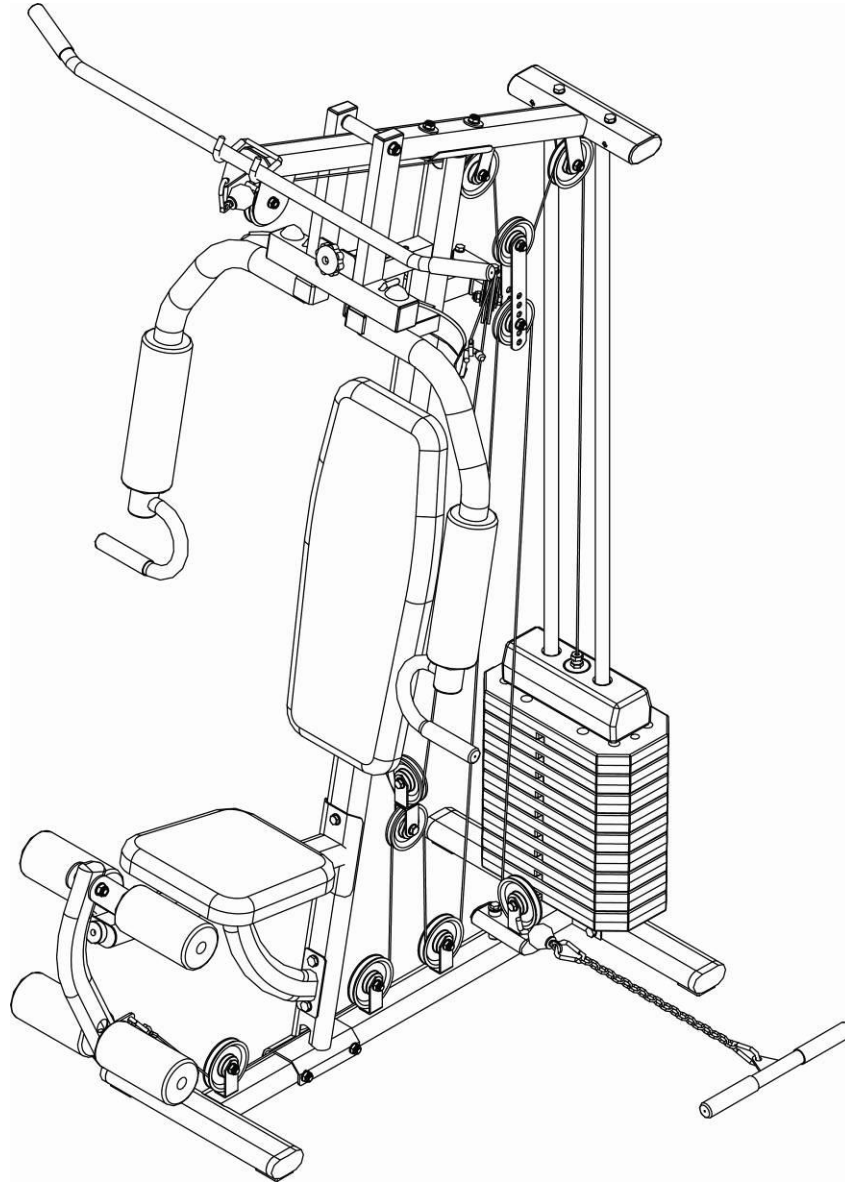

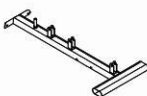







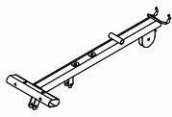



































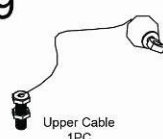
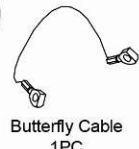





























OHG3067 HOME GYM



PARTS LIST DRAWINGS

<p>1</p>  <p>Base Frame 1PC</p>	<p>2</p>  <p>Back Cross Frame 1PC</p>	<p>3</p>  <p>Top Cross Frame 1PC</p>	<p>4</p>  <p>Butterfly Extension 1PC</p>	<p>5</p>  <p>Main Upright Frame 1PC</p>
<p>6</p>  <p>Seat Cushion Frame 1PC</p>	<p>7</p>  <p>Leg Extension Frame 1PC</p>	<p>8</p>  <p>Right Butterfly Arm 1PC</p>	<p>9</p>  <p>Left Butterfly Arm 1PC</p>	<p>10</p>  <p>Hand Tube 2PCS</p>
<p>11</p>  <p>Support Frame 1PC</p>	<p>12</p>  <p>Lat Bar 1PC</p>	<p>13</p>  <p>Weight Guide Tube 2PCS</p>	<p>14</p>  <p>Foam Tube 2PCS</p>	<p>15</p>  <p>Selector Shaft 1PC</p>
<p>16</p>  <p>Pulley Patch 2PCS</p>	<p>17</p>  <p>Reverse U 1PC</p>	<p>18</p>  <p>Single Pulley Bracket 2PCS</p>	<p>19</p>  <p>Low Pull Seat 1PC</p>	<p>20</p>  <p>Low Bar 1PC</p>
<p>21</p>  <p>Backrest Cushion 1PC</p>	<p>22</p>  <p>Seat Cushion 1PC</p>	<p>23</p>  <p>Leg Foam Roller 4PCS</p>	<p>24</p>  <p>Arm Foam Roller 2PCS</p>	<p>25</p>  <p>Top Weight Plate 1PC</p>
<p>26</p>  <p>Weight Plate 9PCS</p>	<p>27</p>  <p>Selector Shaft Bushing 1PC</p>	<p>28</p>  <p>Selector Shaft Pin 1PC</p>	<p>29</p>  <p>Plastic Washer 1PC</p>	<p>30</p>  <p>Round Rubber Bumper 2PCS</p>
<p>31</p>  <p>L-Pin 2PCS</p>	<p>32</p>  <p>Weight Selector Pin 1PC</p>	<p>33</p>  <p>Selector Shaft End Plug 1PC</p>	<p>34</p>  <p>Tobacco-pipe 1PC</p>	<p>35</p>  <p>Plum Blossom Nut 1PC</p>
<p>36</p>  <p>Pulley 13PCS</p>	<p>37</p>  <p>Chain 1PC</p>	<p>38</p>  <p>Pothook 4PCS</p>	<p>39</p>  <p>Upper Cable 1PC</p>	<p>40</p>  <p>Butterfly Cable 1PC</p>
<p>41</p>  <p>Lower Cable 1PC</p>	<p>42</p>  <p>Oil Bushing(Big) 4PCS</p>	<p>43</p>  <p>Oil Bushing(Small) 2PCS</p>	<p>44</p>  <p>Ankle Strap 1PC</p>	<p>45</p>  <p>Rubber Bumper 1PC</p>
<p>46</p>  <p>Bumper Cap 2PCS</p>	<p>47</p>  <p>Plastic Dome Cap 2PCS</p>	<p>48</p>  <p>Plastic Cover 2PCS</p>	<p>49</p>  <p>Rubber Cushion 1PC</p>	<p>50</p>  <p>Hook Cover 2PCS</p>

PARTS LIST DRAWINGS

<p>51</p>  <p>Handle Grip 6PCS</p>	<p>52</p>  <p>Ellipse Outside Plug(40X80) 4PCS</p>	<p>53</p>  <p>Ellipse Inside Plug(40X80) 3PCS</p>	<p>54</p>  <p>Ellipse Inside Plug(30X70) 2PCS</p>	<p>55</p>  <p>Ellipse Inside Plug(30X60) 2PCS</p>
<p>56</p>  <p>50mm Round End Plug 4PCS</p>	<p>57</p>  <p>25mm Round End Plug 4PCS</p>	<p>58</p>  <p>Square End Plug 2PCS</p>	<p>59</p>  <p>Square End Plug (25X50) 2PCS</p>	<p>60</p>  <p>Hex Bolt M12x155mm 1PC</p>
<p>61</p>  <p>Hex Bolt M12x75mm 1PC</p>	<p>62</p>  <p>Hex Bolt M10x105mm 4PCS</p>	<p>63</p>  <p>Hex Bolt M10x60mm 4PCS</p>	<p>64</p>  <p>Hex Bolt M10x45mm 13PCS</p>	<p>65</p>  <p>Hex Bolt M10x20mm 4PCS</p>
<p>66</p>  <p>Hex Bolt M10x15mm 4PCS</p>	<p>67</p>  <p>Hex Bolt M8x65mm 2PCS</p>	<p>68</p>  <p>Hex Bolt M8x40mm 1PC</p>	<p>69</p>  <p>Hex Bolt M8x15mm 11PCS</p>	<p>70</p>  <p>Bolt M8x15mm 8PCS</p>
<p>71</p>  <p>Bolt M6x15mm 1PC</p>	<p>72</p>  <p>Washer (φ 30Xφ 10) 1PC</p>	<p>73</p>  <p>Washer (M12) 6PCS</p>	<p>74</p>  <p>Washer(M10) 46PCS</p>	<p>75</p>  <p>Arc Washer (M10) 4PCS</p>
<p>76</p>  <p>Washer (M8) 16PCS</p>	<p>77</p>  <p>Arc Washer (M8) 8PCS</p>	<p>78</p>  <p>Big Washer (M8) 1PC</p>	<p>79</p>  <p>Nylon Nut M12 4PCS</p>	<p>80</p>  <p>Nylon Nut M10 21PCS</p>
<p>81</p>  <p>Nylon Nut M8 3PCS</p>				

ASSEMBLY INSTRUCTIONS

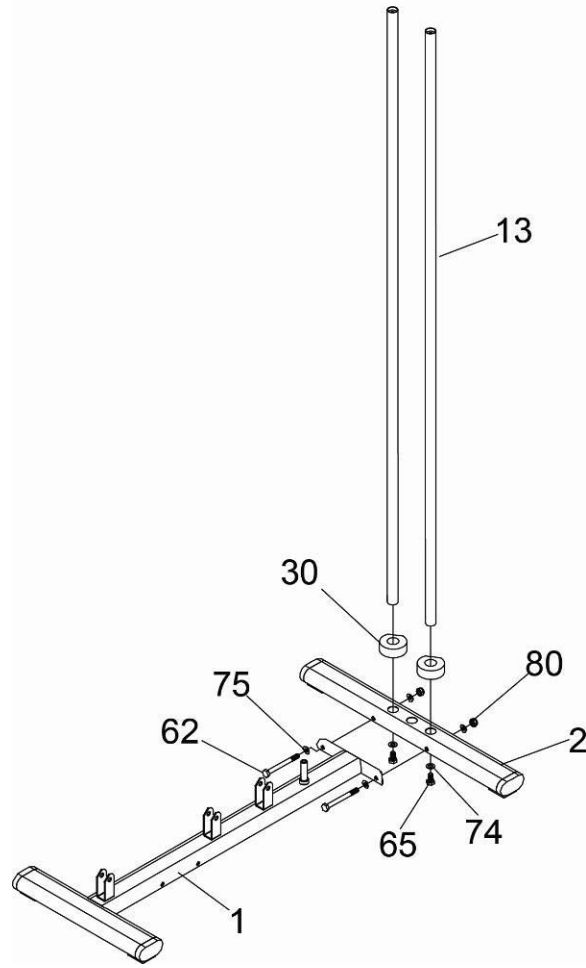

STEP 1

1. Secure Base Frame (1) with Back Base Frame (2), using two M10X105mm Hex Bolt (62), four M10 Arc Washers (75) and two M10 Nylon Nuts (80).
2. Remove two M10X25mm Hex Bolts (65) and two M10 Washers (74) from two Weight Guide Tubes (13).
3. Insert two Weight Guide Tubes (13) into Back Base Frame (2) using two M10X25mm Hex Bolts (65) and two M10 Washers (74) secure it.
4. Slide two Round Rubber Bumpers (30) onto two Weight Guide Tubes (13).

ASSEMBLY INSTRUCTIONS

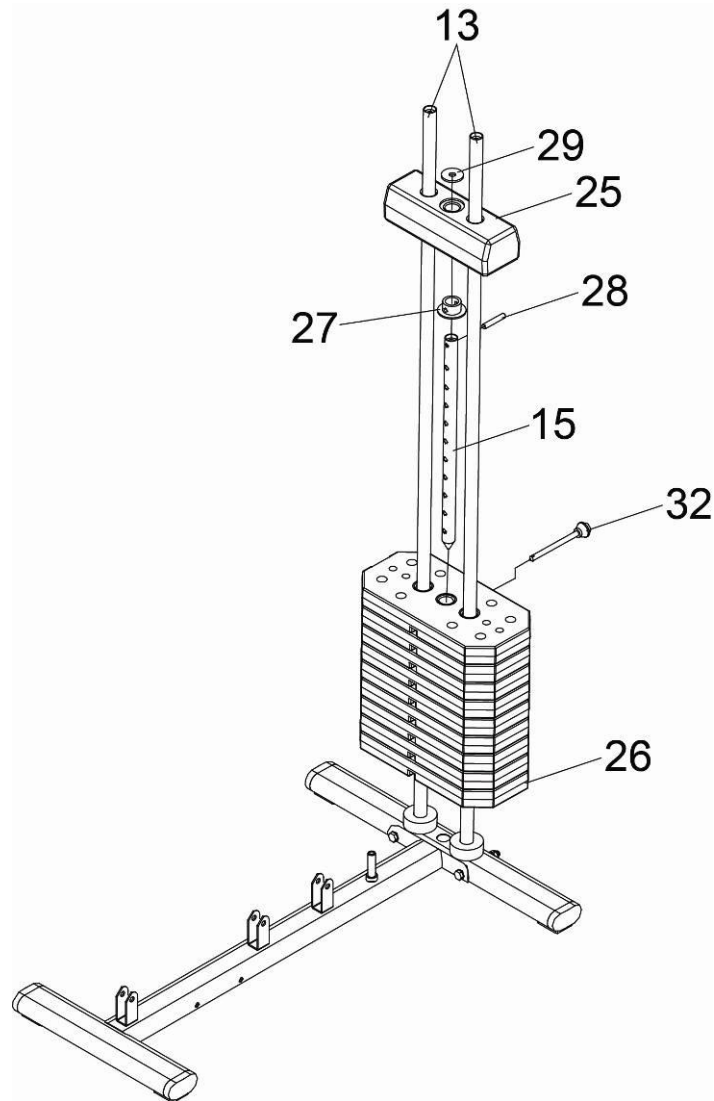

STEP2:

1. Slide nine Weight Plates (26) down two Weight Guide Tubes (13).
2. Slide Selector Shaft Bushing (27) down Selector Shaft (15) at first hole and fix with Selector Shaft Pin (28).
3. Insert Selector Shaft (15) into hole of Weight Plate (26).
4. Slide Top Weight Plate (25) down Weight Guide Tubes (13), Insert Weight Selector Pin (32) into hole of your desired weight.
5. Slide Plastic Washer (29) to Top Weight Plate (25).

ASSEMBLY INSTRUCTIONS

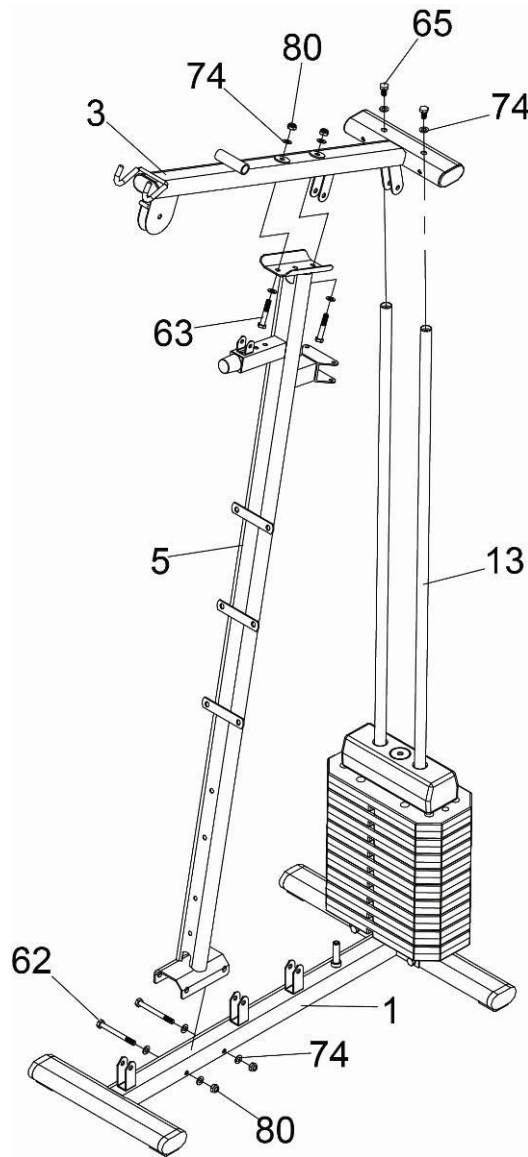

STEP 3:

1. Attach Main Upright Frame (5) to Base Frame (1) using two M10X105mm Hex Bolts (62), four M10 Washers (74) and two Nylon Nuts (80).
2. Remove two M10X25mm Hex Bolts (65) and two M10 Washers (74) from two Weight Guide Tubes (13).
3. Attach Top Cross Frame (3) to two Weight Guide Tubes (13) using two M10X20mm Hex Bolts (65) and two M10 Washers (74).
4. Attach Top Cross Frame (3) to Main Upright Frame (5) using two M10X60mm Hex Bolts (63), four M10 Washers (74) and two M10 Nylon Nuts (80).

ASSEMBLY INSTRUCTIONS

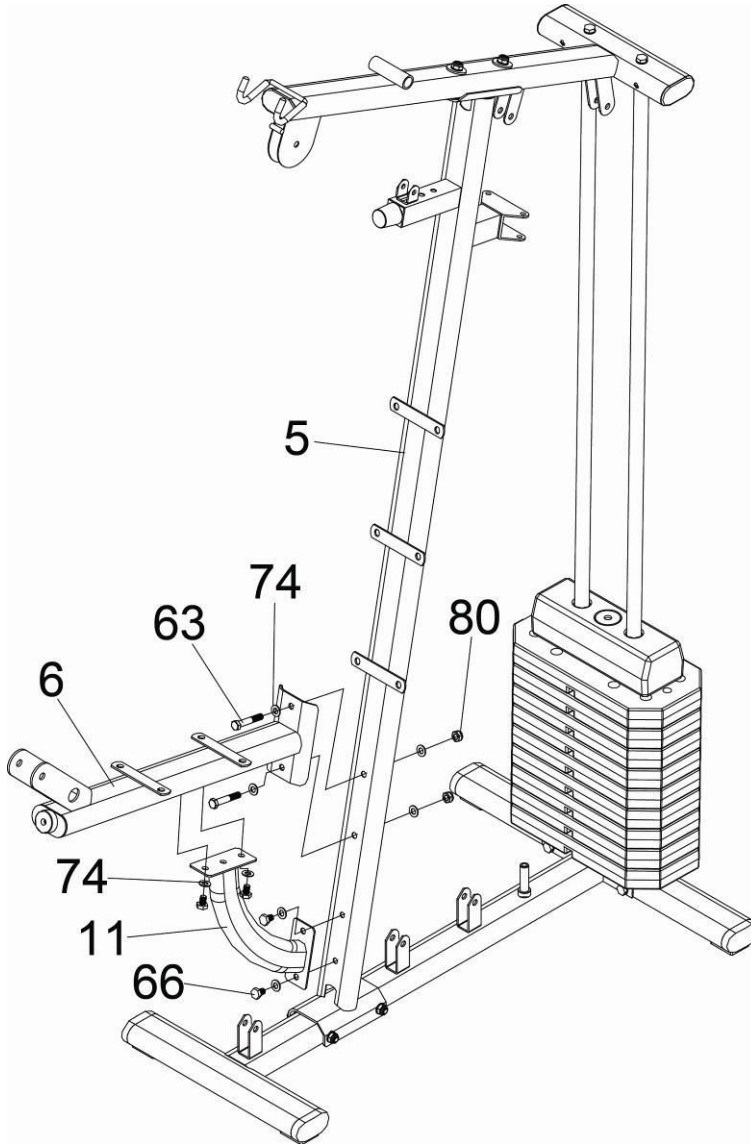

STEP 4:

1. Attach Support Frame (11) to Main Upright Frame (5) using two M10X15mm Hex Bolts (66) and two M10 Washers (74).
2. Attach Seat Cushion Frame (6) to Main Upright Frame (5) and Support Frame (11) using two M10X60mm Hex Bolt (63), two M10X15mm Hex Bolts (66), six M10 Washers (74) and two M10 Nylon Nuts (80).

ASSEMBLY INSTRUCTIONS

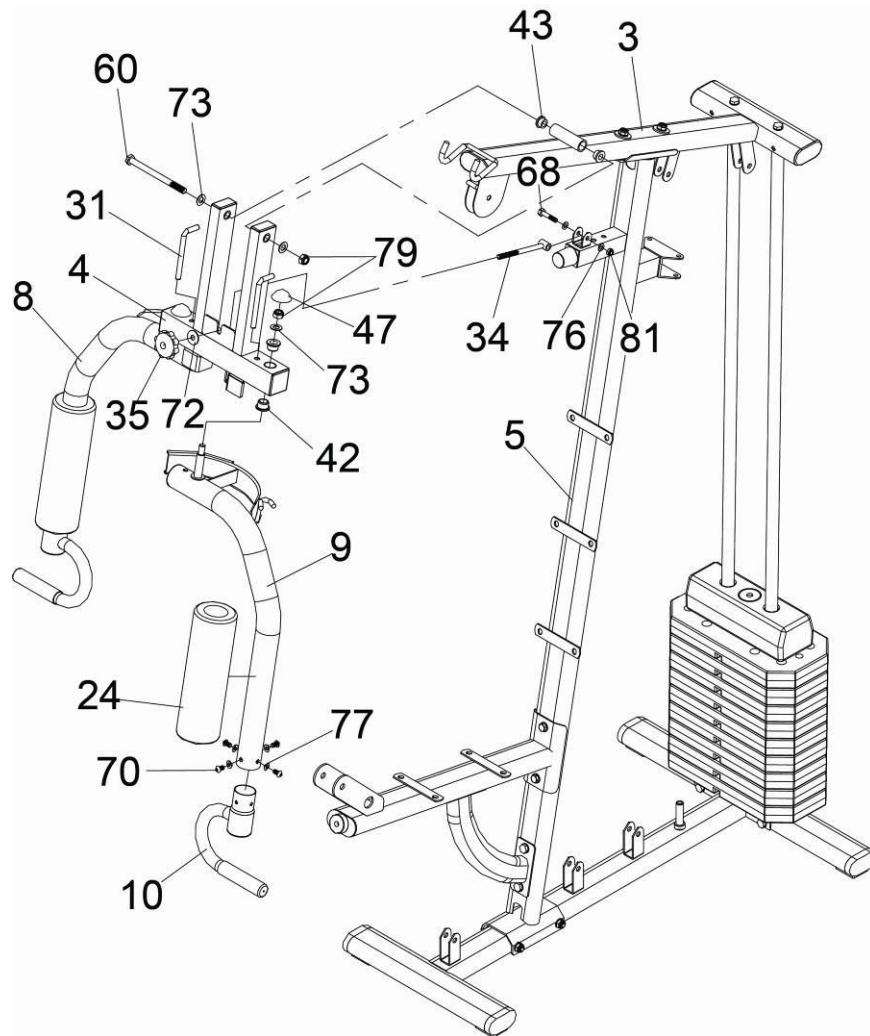

STEP 5:

1. Attach Butterfly Extension (4) to Top Cross Frame (3), using two Oil Bushing (small) (43), one M12x155mm Hex Bolt (60), two M12 Washers (73) and one M12 Nylon Nut (79).
2. Attach Tobacco-pipe (34) to Main Upright Frame (5) using one M8x40mm Hex Bolt (68), two M8 Washers (76) and one M8 Nylon Nut (81).
3. Slide $\varnothing 30 \times \varnothing 10$ Washer (72) and Plum Blossom Nut (35) onto Tobacco-pipe (34).
4. Attach Left Butterfly Arm (9) to Butterfly Extension (4) using two Oil Bushings (big) (42), one M12 Washer (73), one M12 Nylon Nut (79) and one Plastic Dome Cap (47).
5. Insert L-Pin (31) into Butterfly Extension (4) and Left Butterfly Arm (9).
6. Slide Arm Foam Roller (24) onto Left Butterfly Arm (9).
7. Insert Hand Tube (10) into Left Butterfly Arm (9) using four M8x15mm Bolts (70) and four M8 Arc Washers (77).
8. Assembly Right Butterfly Arm (8) with same method.

ASSEMBLY INSTRUCTIONS

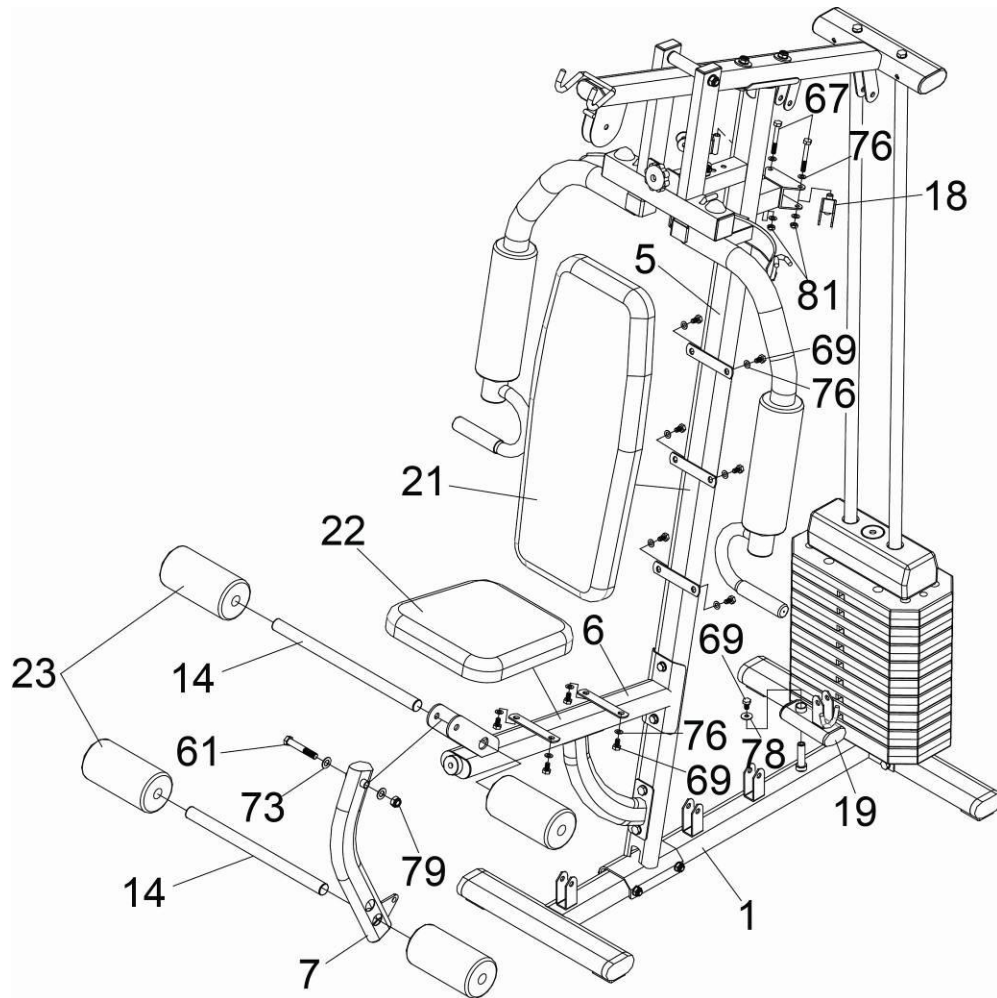

STEP 6:

1. Attach Leg Extension Frame (7) to Seat Cushion Frame (6), using one M12x75mm Hex Bolts (61), two M12 Washers (73) and one M12 Nylon Nuts (79).
2. Insert two Foam Tubes (14) into Seat Cushion Frame (6) and Leg Extension Frame (7).
3. Slide four Leg Foam Rollers (23) onto two Foam Tubes (14).
4. Attach two Single Pulley Brackets (18) to Main Upright Frame (5), using two M8x65mm Hex Bolts (67), four M8 Washers (76) and two M8 Nylon Nuts (81).
5. Attach Low Pull Seat (19) down Base Frame (1), using one M8x15mm Hex Bolt (69) and one M8 Big Washer (78).
6. Attach Backrest Cushion (21) to Main Upright Frame (5), using six M8x15mm Hex Bolts (69) and six M8 Washers (76).
7. Attach Seat Cushion (22) to Seat Cushion Frame (6) using four M8x15mm Hex Bolts (69) and four M8 Washers (76).

ASSEMBLY INSTRUCTIONS

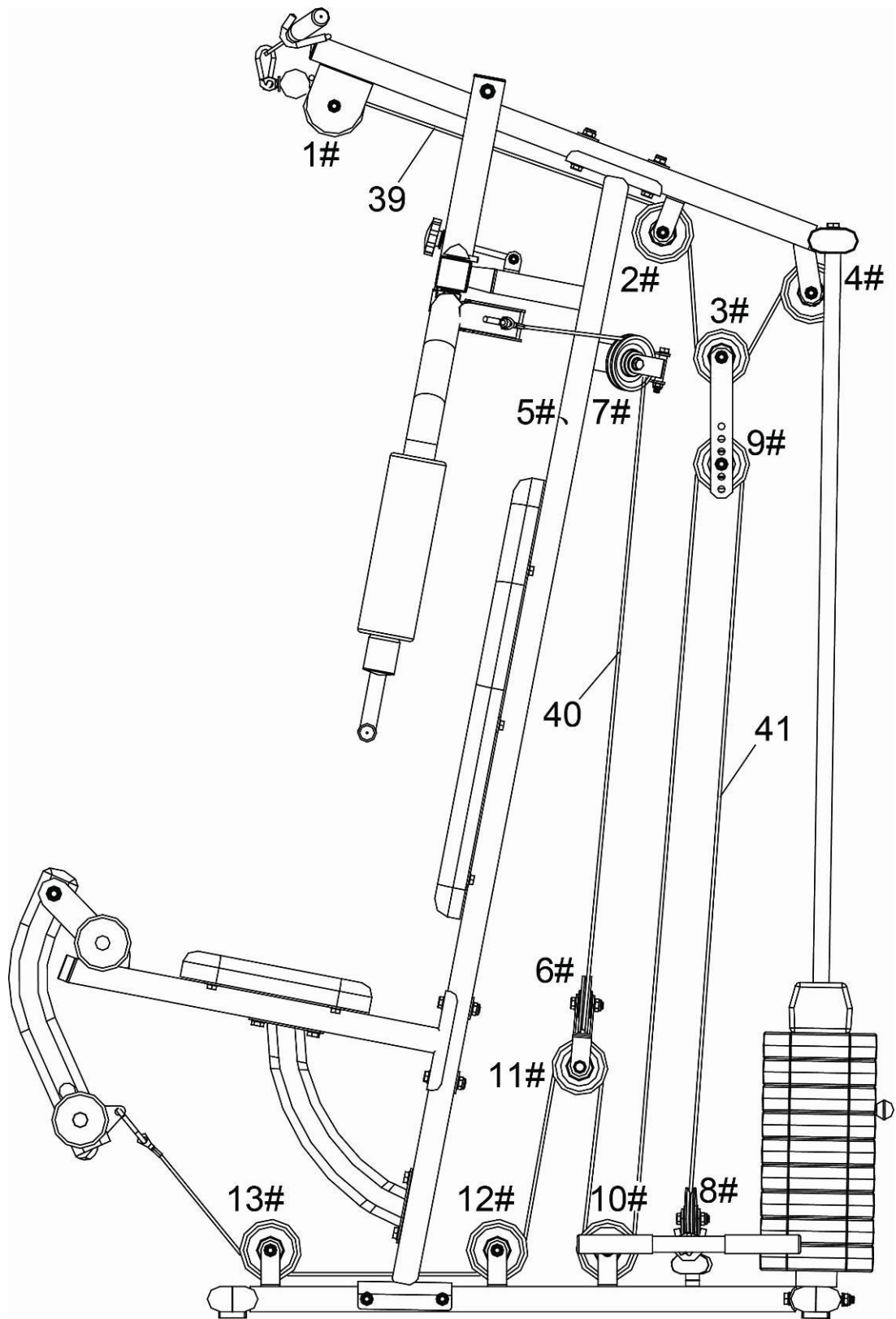

ASSEMBLY INSTRUCTIONS

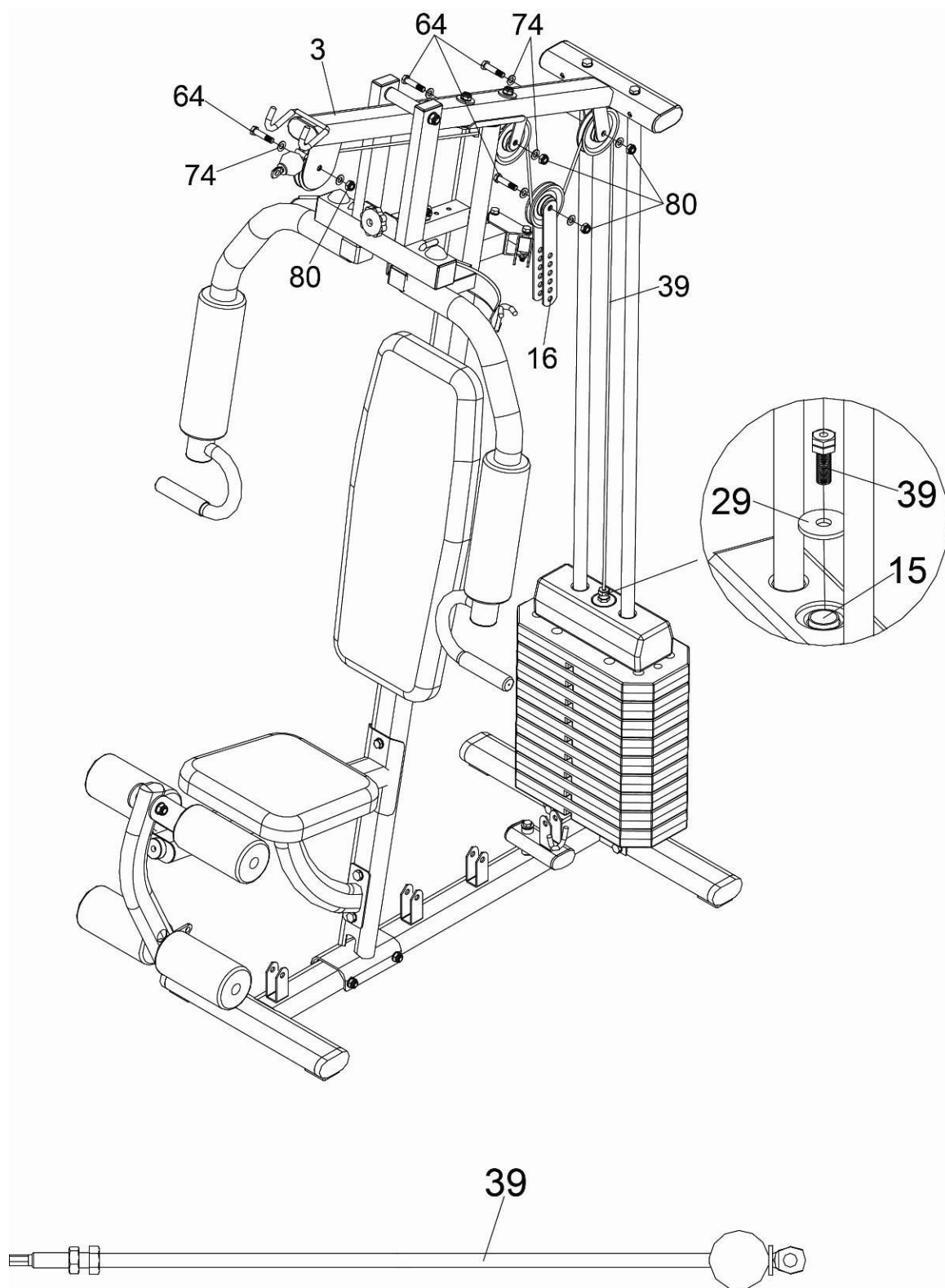

ASSEMBLY INSTRUCTIONS

STEP 7: Start with the Upper Cable (39)

- a.) With Upper Cable (39) in groove of Pulley (36) through the Top Cross Frame (3).
- b.) Install Pulley NO.1 (36) to the Top Cross Frame (3) using one M10X45mm Hex Bolt (64), two M10 Washers (74) and one M10 Nylon Nut (80).
- c.) Install Pulley NO.2 (36) to the Top Cross Frame (3) using one M10X45mm Hex Bolt (64), two M10 Washers (74) and one M10 Nylon Nut (80).
- d.) Install Pulley NO.3 (36) to two Pulley Patches (16) using one M10X45mm Hex Bolt (64), two M10 Washers (74) and one M10 Nylon Nut (80).
- e.) Install Pulley NO.4 (36) to the Top Cross Frame (3), using one M10X45mm Hex Bolt (64), two M10 Washers (74) and one M10 Nylon Nut (80).
- h.) Attach the bolt end of the Upper Cable (39) to the Selector Shaft (15) with Plastic Washer (29).

ASSEMBLY INSTRUCTIONS

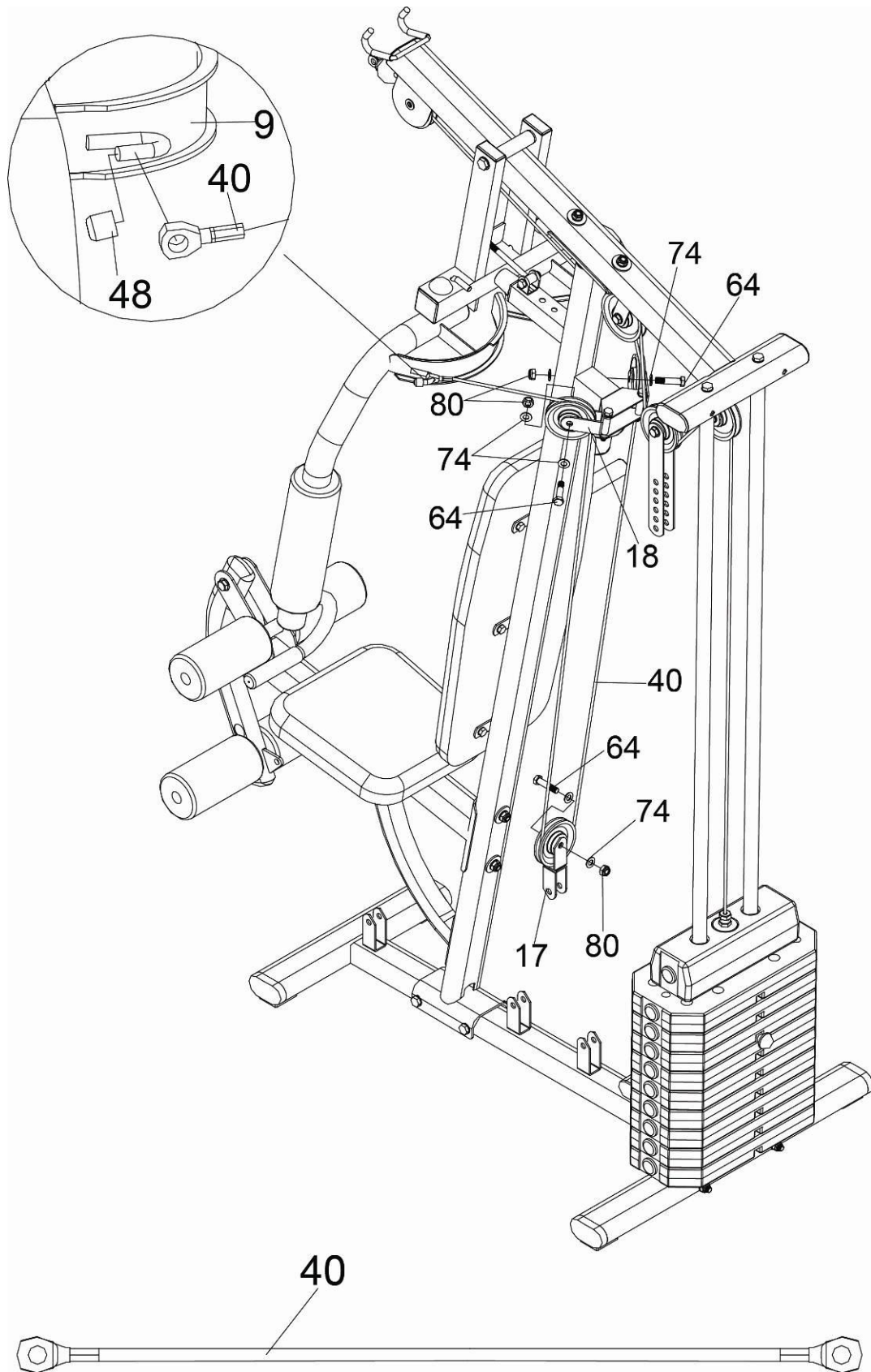

ASSEMBLY INSTRUCTIONS

STEP 8: Assembly with the Butterfly Cable (40)

- a.) Attach the Butterfly Cable (40) to the Left Butterfly Arm (9) and the Right Butterfly Arm (8), using two Plastic Bushings (48).
- b.) Install Pulley NO.5&7 (36) to two Single Pulley Blocks (18), using two M10X45mm Hex Bolts (64), four M10 Washers (74) and two M10 Nylon Nuts (80).
- c.) Install Pulley NO.6 (36) to the Reverse U (17) using one M10X45mm Hex Bolt (64), two M10 Washers (74) and one M10 Nylon Nut (80).

ASSEMBLY INSTRUCTIONS

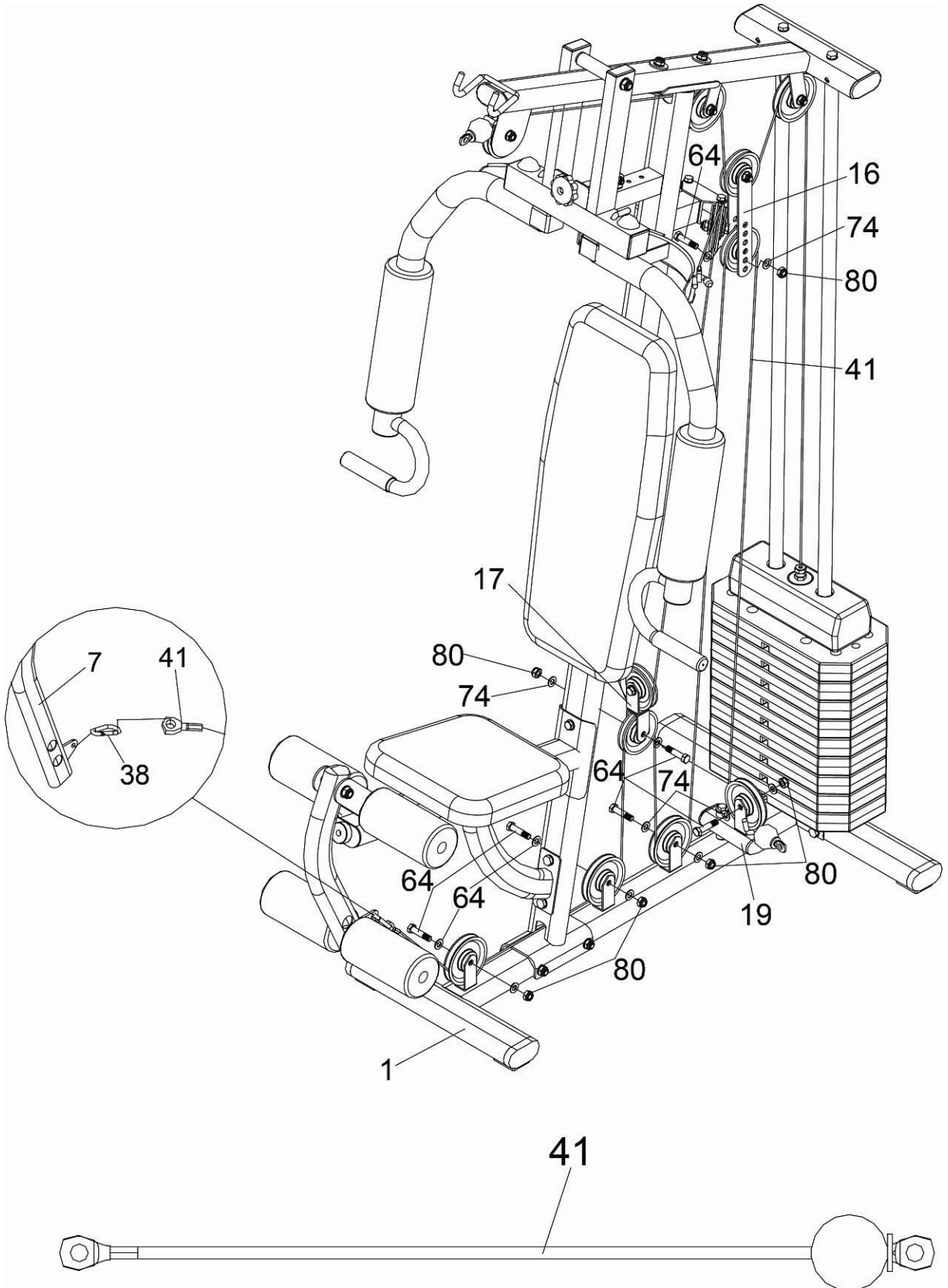

ASSEMBLY INSTRUCTIONS

STEP 9: Assembly the Lower Cable (41)

- a.) Install Pulley NO.8 (36) to the Low Pull Seat (19), using one M10X45mm Hex Bolt (64), two M10 Washers (74) and one M10 Nylon Nut (80).
- b.) Install Pulley NO.9 (36) to two Pulley Patches (16), using one M10X45mm Hex Bolt (64), two M10 Washers (74) and one M10 Nylon Nut (80).
- c.) Install Pulley NO.10 (36) to the Base Frame (1), using one M10X45mm Hex Bolt (64), two M10 Washers (74) and one M10 Nylon Nut (80).
- d.) Install Pulley NO.11 (36) to the Reverse U (17), using one M10X45mm Hex Bolt (64), two M10 Washers (74) and one M10 Nylon Nut (80).
- e.) Install Pulley NO.12 (36) to the Base Frame (1), using one M10X45mm Hex Bolt (64), two M10 Washers (74) and one M10 Nylon Nut (80).
- f.) Install Pulley NO.13 (36) to the Base Frame (1), using one M10X45mm Hex Bolt (64), two M10 Washers (74) and one M10 Nylon Nut (80).
- g.) Attach the end of Lower Cable (41) to the Leg Extension Frame (7) using one Pothook (38).

ASSEMBLY INSTRUCTIONS

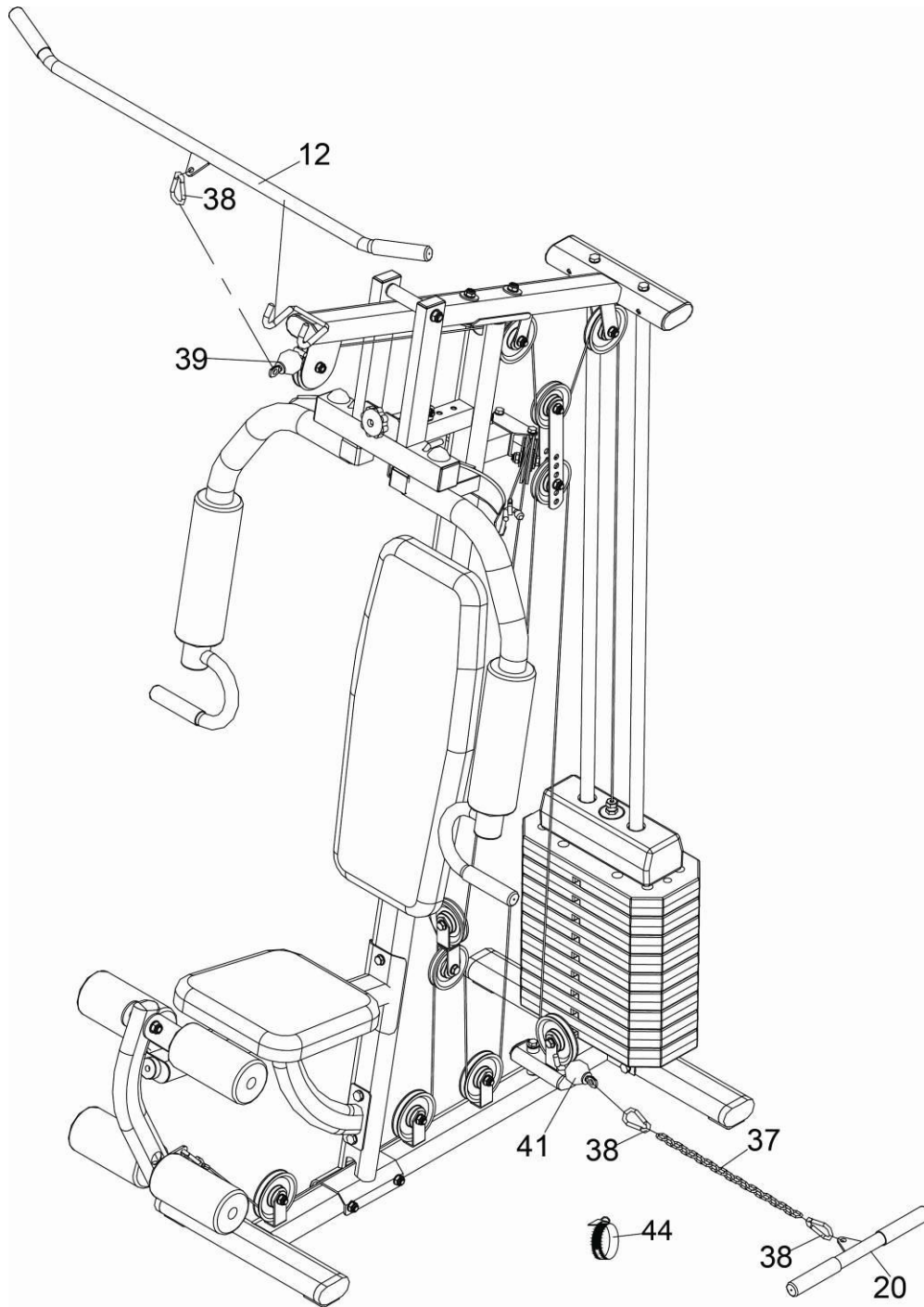

STEP 10

1. Attach the Lat Bar (12) to the end of Upper Cable (39), using one Pothook (38).
2. Attach the Low Bar (20) or Ankle Strap (44) to the end of Lower Cable (41), using two Pothooks (38) and one Chain (37).

